

SOLAR VENTILATOR

Model No.:GM712

U. S. A. PATENT NO. : 29/079.267 (D409,741)
HONG KONG PATENT NO. : 9710449.9
TAIWAN PATENT NO. : 86309861 (64619)
CHINA PATENT NO. : 97329564.3

INSTRUCTIONS OF HOW TO FIX:

BRICK WALL, METAL, WOOD, FIBRE AND OTHER MATERIAL FIXING:

irregular hole

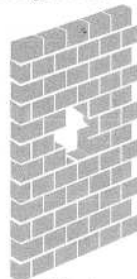

FIG. 1

small holes

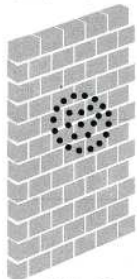

FIG. 2

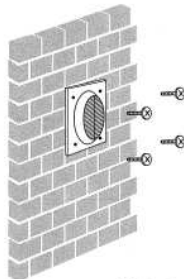

FIG. 3

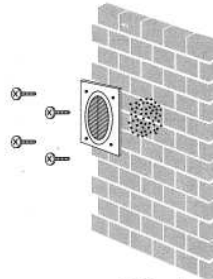

FIG. 4

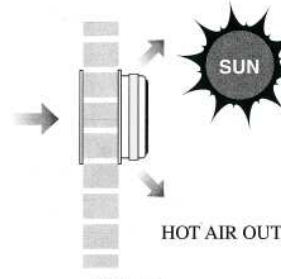

FIG. 5

1. Find out the best location and direction where there is maximum sunlight for the unit, and face the sunlight directly. The more sunlight it receives, the more power for the ventilator to run efficiently. (see fig 5).
2. Undo the 4 pieces plastic adaptors and screws from the ventilator base bottom.
3. Put the unit on the wall and mark on the 4 corner holes position (see fig 2) and the area for small holes (see fig 2).
4. Drill some small holes on the brick wall at the size about 134mm area, or chop an irregular size hole (no bigger than 130mm square). These holes are for the air to go through. (see fig 1 & 2) and drill 4 holes for mounting the unit purpose (see fig 1 & 2).
5. Put some silicon glue on the ventilator bottom surface to the edge of the unit, in order to prevent water go in the house when there is rainy day.
6. Put the unit to cover on the holes and fix with screws tightly (see fig 3).
7. Put the outlet cover to mark and drill the 4 corner screws.
8. Put the outlet cover to cover the holes tightly with 4 screws (see fig 4).
9. This ventilator can be easily released off by twist anti-clockwise (see fig 6), for cleaning dust after long period running. To fix the unit by twisting clockwise into the 4 slots (see fig 7).

Note: For your safety, it is recommended not to release off the unit for cleaning if it is fixed in a high position, unless made by the experienced technician.

1. To release off by twist anti-clockwise

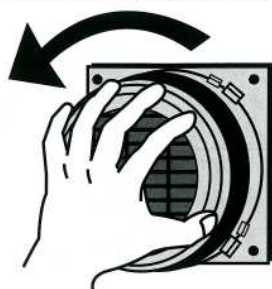

FIG. 6

2. To replace in by twist clockwise



FIG. 7

SOLAR VENTILATOR

Model No.:GM712

U. S. A. PATENT NO. : 29/079,267 (D409,741)
HONG KONG PATENT NO. : 9710449.9
TAIWAN PATENT NO. : 86309861 (64619)
CHINA PATENT NO. : 97329564.3

INSTRUCTIONS OF HOW TO FIX:

GLASS FIXING

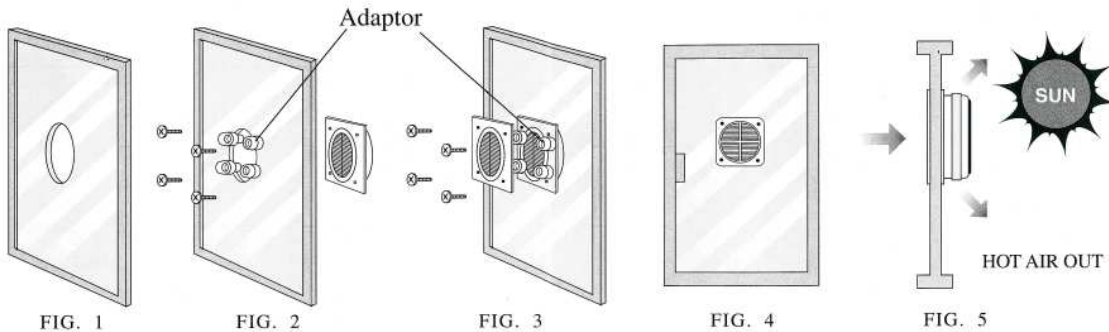

1. Find out the best location and direction where there is maximum sunlight for the unit, and face the sunlight directly. This ventilator can be fixed to any angle position. Fix the ventilator to face sunlight directly. The more sunlight it receives, the more power for the ventilator to run efficiently. (see fig 5)
2. Cut a round hole with diameter between $\text{Ø } 134\text{mm}$ and $\text{Ø } 137\text{mm}$ (suggested size $\text{Ø } 135\text{mm}$) - (see fig 1)
3. It is also possible to fix into a square hole by the size $135\text{mm} \times 135\text{mm}$ (but cut square hole is more difficult than a round hole).
4. Put the unit to cover outside the window and use 4 pieces plastic adaptor for mounting tightly - (see fig 2)
5. Use silicon rubber glue to seal the edge inside the glass.
6. Put the outlet cover to cover inside the window hole with screws tightly - (see figure 3 & 4)
7. This ventilator can be easily released off by twist anti-clockwise (see fig 6), for cleaning dust after long period running. To replace in the unit by twisting clockwise into the 4 slots (see fig 7).

Note: For your safety, it is recommended not to release off the unit for cleaning if it is fixed in a high position, unless made by the experienced technician.

1. To release off by twist anti-clockwise

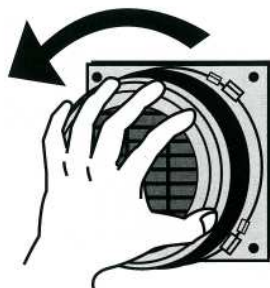

FIG. 6

2. To replace in by twist clockwise



FIG. 7

Medidas:

15,50 x 15,50 x 7,50 com

Utilizações:

Use for: your garage, shield, outhouse, caravan boat, holidays home, conservatories, porpacabins, farm building, temporary building, lofts, stable, road transport and many others.... etc.

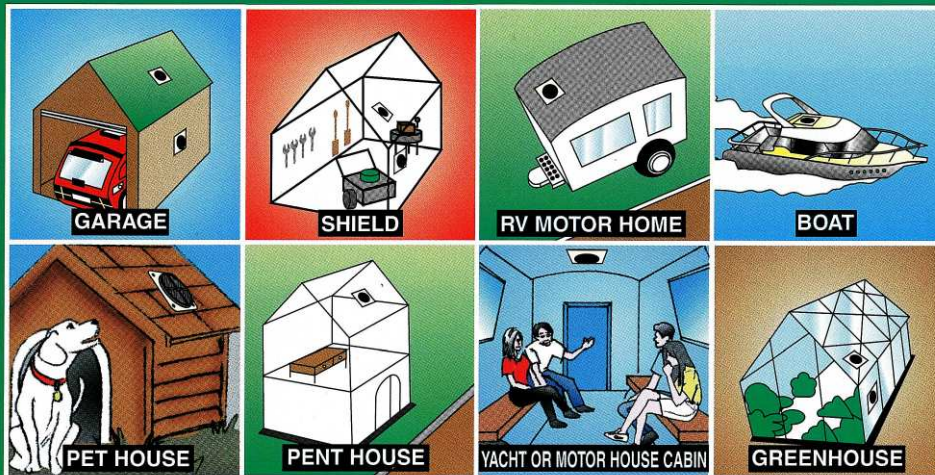

It can also be used for: your home unit, for hot air out, after you come back home from work. Or after you leave your house empty for some time like long vacation outside, as it keeps the air fresh and no stale odours.

